



Level



Pressure



Flow



Temperature



Liquid
Analysis



Registration



Systems
Components



Services



Solutions

Technical Information

Nivotester FTC325

Level limit switch

With Intrinsically Safe Signal Circuit for Connection
to a Capacitance Sensor



Applications

- Level limit detection in tanks containing liquids and silos containing bulk solids. For capacitance level probes, which may also be applied in hazardous areas of category ATEX II (1) GD
- Overspill protection for tanks containing flammable or non-flammable fluids hazardous to water
- Dry running protection for pumps
- Two-point control (Δs with 3-WIRE)

Your benefits

- Intrinsically safe signal circuit [EEx ia] IIC for using sensors in hazardous areas
- Calibration using operating keys
- High functional safety thanks to:
 - fail-safe pulse-frequency modulation (PFM) or 3-WIRE technology
 - Checkable relay function
- Compact housing for easy series mounting on a standard DIN rail in the cabinet
- Pluggable terminal blocks make wiring easy
- Can be used with FEI57S (PFM), EC16Z (PFM), EC17Z (PFM), FEI53 (3-WIRE) and EC61 (3-WIRE)
- Limit value and alarm relay
- WHG approval (PFM)
- Protection against maloperation and manipulation
 - each change of the device configuration leads to signalling via the red LED and a fault message

Table of contents

Function and system design	3	Supplementary Documentation	19
Measuring principle	3	System Information (SI)	19
Measuring device	5	Technical Information (TI)	19
Input parameters	8	Operating manual (KA)	19
Measured variable	8	Certificates (only for PFM)	19
Measuring range	8		
Input signal	8		
Output parameters	9		
Output signal	9		
Signal on alarm	9		
Galvanic isolation	9		
Overvoltage category as per EN 61010	9		
Protection class	9		
Power supply	10		
Electrical connection	10		
Supply voltage	10		
Power consumption	10		
Operating conditions (installation conditions)	11		
Installation instructions	11		
Operating conditions (environmental conditions)	12		
Installation location	12		
Permitted ambient temperatures	12		
Climatic and mechanical application class	12		
Degree of protection	12		
Electromagnetic compatibility (EMC)	12		
Mechanical construction	13		
Design, dimensions	13		
Weight	14		
Materials	14		
Terminals	14		
User interface	15		
Display elements	15		
Operating elements	15		
Operating elements	16		
Certificates and approvals	17		
CEmark	17		
Ex approval	17		
Type of protection	17		
Overspill protection	17		
Other standards and regulations	17		
Ordering information	18		
Nivotester FTC325 PFM	18		
Nivotester FTC325 3-WIRE	18		
Accessories	19		
Protective housing	19		

Function and system design

Measuring principle

Function

Probe and tank (or ground tube/counterpotential) form a capacitor whose capacitance changes with the level of the product.

PFM	3-WIRE
The electronic insert FEI57, EC16Z or EC17Z converts the change of capacitance into a change of frequency, which switches the output relay in the Nivotester FTC325 PFM.	The electronic insert FEI53 or EC61 converts the change of capacitance into a voltage signal, which switches the output relay in the Nivotester FTC325 3-WIRE.

Signal transmission

The signal input of the Nivotester FTC325 limit switch is galvanically isolated from the mains and from the output.

PFM	3-WIRE
The Nivotester supplies the capacitance sensor with intrinsically safe direct current via a two-wire cable and from there receives a frequency, which signals whether the level limit has been reached or not. Here, the transmitter superimposes current impulses (PFM signals) with a pulse width of approx. 200 µs and a current intensity of approx. 10 mA on the supply current. The measuring capacitance lies in the range from 20 pF... 350pF. This corresponds to a transmission frequency of 185 Hz...116 Hz.	The Nivotester supplies the capacitance sensor with direct current via a two-wire cable and receives the voltage signal via a third wire, which signals whether the level limit has been reached or not. The measuring capacitance lies in the range from 10 pF...350 pF. This corresponds to a voltage of 3 V...12 V.

Signal evaluation

The Nivotester analyses the frequency or the voltage signal, and switches the output relay for the level alarm. The switching state of the relay (energised or de-energised) is displayed on the front panel of the Nivotester by means of two yellow LEDs.

Fail-safe circuit

Selecting the correct fail-safe circuit ensures that the relay always works in quiescent current fail-safe mode.

- Maximum fail-safe mode: the relay de-energises when the level rises above the switch point (sensor covered), a fault occurs or the power fails.
- Minimum fail-safe mode: the relay de-energises when the level falls below the switch point (sensor uncovered), a fault occurs or the power fails.

PFM

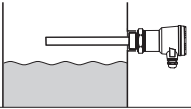
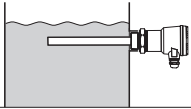
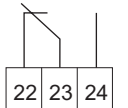
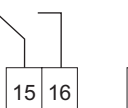
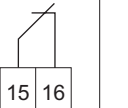
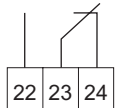
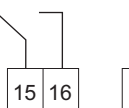
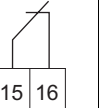
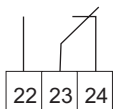
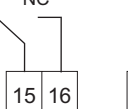
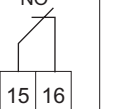
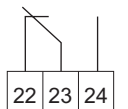
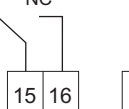
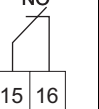
Level	 Probe uncovered	 Probe covered
Maximum safety circuit	  	  
Minimum safety circuit	  	  

L00-FTC325xx-15-06-xx-en-001

Function of the limit indicator dependent on the level and fail-safe circuit.

3-WIRE

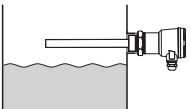
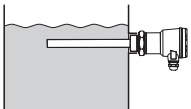
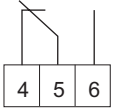
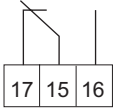
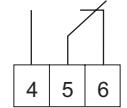
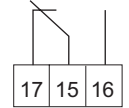
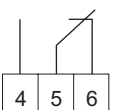
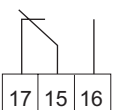
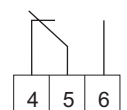
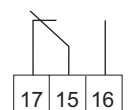
Level	 Probe uncovered	 Probe covered
Maximum safety circuit	 	 
Minimum safety circuit	 	 

L00-FTC325xx-15-06-xx-en-002

Function of the limit indicator dependent on the level and fail-safe circuit.

Function monitoring

To increase operational safety the Nivotester is equipped with a function monitoring facility. A fault is displayed by the red light emitting diode and de-energises the relay for the level alarm and the alarm relay. A fault is reported if the Nivotester is no longer receiving a measuring signal. This occurs, for example, when:

- there is a short-circuit
- the signal line to the sensor is interrupted
- the sensor electronics are defective
- the Nivotester's input switching is defective

After calibration, every further change to the device configuration de-energises the relay. A fault message is signalled via the red LED.

Calibration key (red)

Calibration is carried out automatically by means of operating keys. This makes setting via rotary switches inapplicable.

The test/correction key (green - FTC325 PFM only):

- allows for a function check of the output relay and alarm relay.
- confirms a change in the operating mode - e.g. by changing the switching delay after initial calibration. This enables a correction of the operating mode without requiring recalibration. The changed settings are saved by pressing the operating key.

Additional switch functions

- An adjustable switching delay of 0...45 s allows for the relay to be switched with a delay when covering or uncovering the probe. In the opposite direction, each switching delay is 0.2 s.
- Two-point control (Δs function, FTC325 3-WIRE), see page 7
- A potentiometer (rotary switch) for shifting the operating point allows safe operation of the system, even with media that are prone to build-up.

Measuring device

A simple measuring system consists of a capacitance sensor, a Nivotester FTC325 and the control or signal instruments.

The following sensors can be used in conjunction with the electronic inserts (EC) listed.

	FTC325 PFM	FTC325 3-WIRE
Liquicap M FTI51, FTI52 with	FEI57S	FEI53
Solicap M FTI55, FTI56 with	FEI57S	FEI53
Solicap S FTI77 with	FEI57S	FEI53
Solicap FTC51*, FTC52*, FTC53* with	EC17Z	EC61
Multicap T* with	EC17Z	EC61
Multicap Classic* with	EC16Z, EC17Z	EC61
Multicap EA* with	EC17Z	
High-temperature probes T12656***, T12892*** with	EC17Z	EC61
High-temperature probe 11500** with	EC17Z	
Double rod probe 11304** with	EC17Z	

* Phase-out: 2007, ** Phase-out: 2008, *** Phase-out: 2009

Probe construction

Example: Material	ϵ_r	Conductivity	Build-up	Type of probe mounting			
				full insulation	partial insulation	with ground tube	without ground tube
Solvents, fuels	< 3	low	low	✓	✓	✓	–
Dry bulk solids	< 3	low	low	–	✓	–	✓
Moist bulk solids	> 3	average	average	✓	✓	–	✓
Aqueous liquids and alcohols	> 3	strong	low	✓	✓	–	✓
			strong	–	✓	–	✓
Sludge	> 3	strong	very strong	–	✓	–	✓

L00-FTC25xx-05-06-xx-es-000

Nivotester FTC325 PFM	Nivotester FTC325 3-WIRE
The measuring system consists of: <ul style="list-style-type: none"> ■ Sensor <ul style="list-style-type: none"> – capacitance probe – electronic insert <ul style="list-style-type: none"> – FEI57S, EC16Z, EC17Z ■ Nivotester FTC325 PFM ■ Control or signal instruments 	The measuring system consists of: <ul style="list-style-type: none"> ■ Sensor <ul style="list-style-type: none"> – one or two capacitance probes – electronic insert <ul style="list-style-type: none"> – FEI53, EC61 ■ Nivotester FTC325 3-WIRE ■ Control or signal instruments

Level limit detection with FTC325 PFM

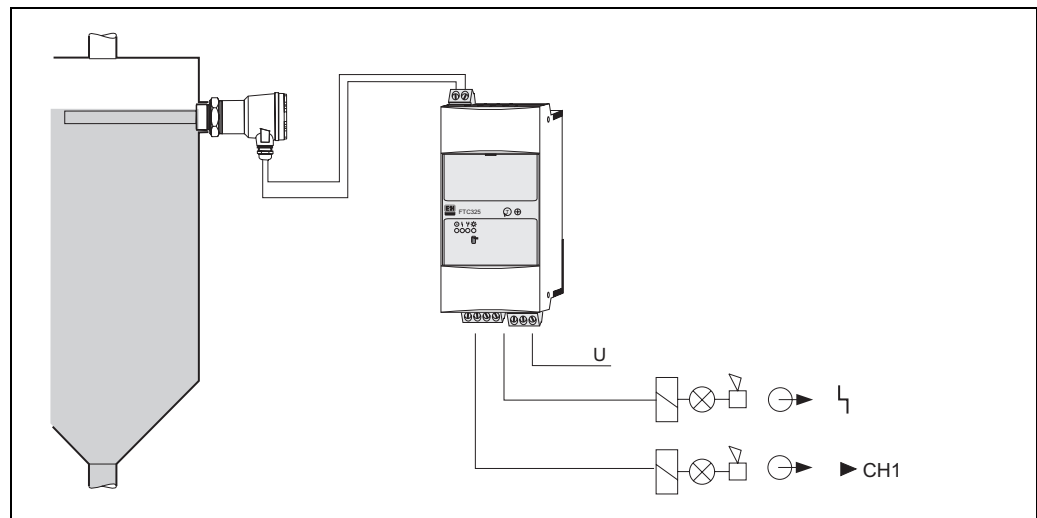

L00-FTC325xx-14-06-xx-xx-001

Partially or fully insulated probe

Level limit detection with FTC325 3-WIRE

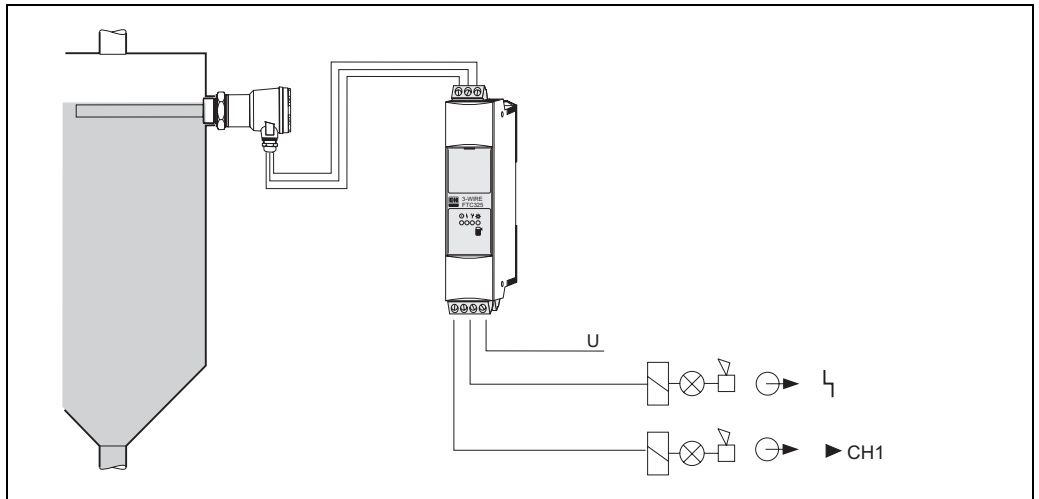

100-FTC325xx-14-06-xx-xx-002

Partially or fully insulated probe

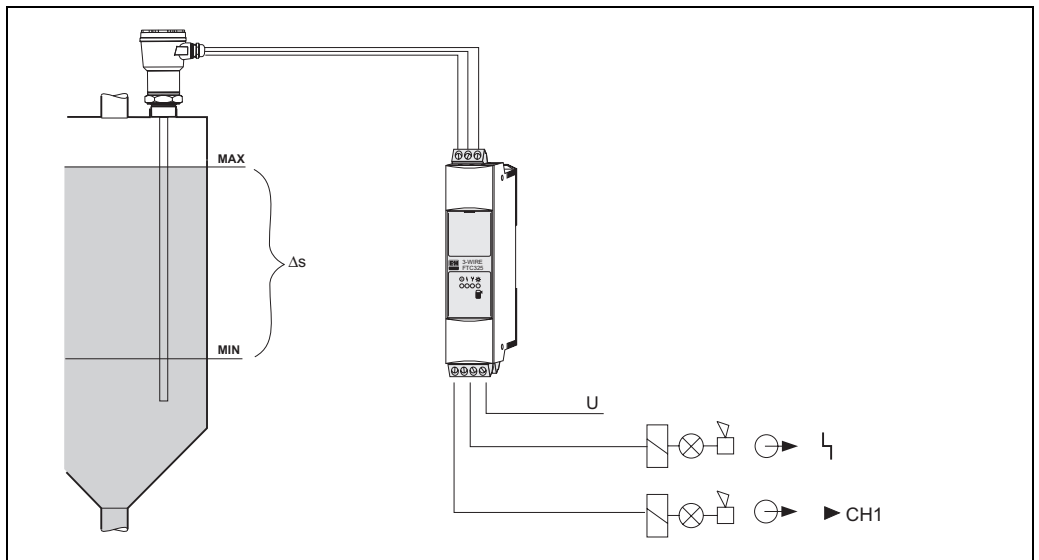

100-FTC325xx-14-06-xx-xx-004

Two-point control with fully insulated probe

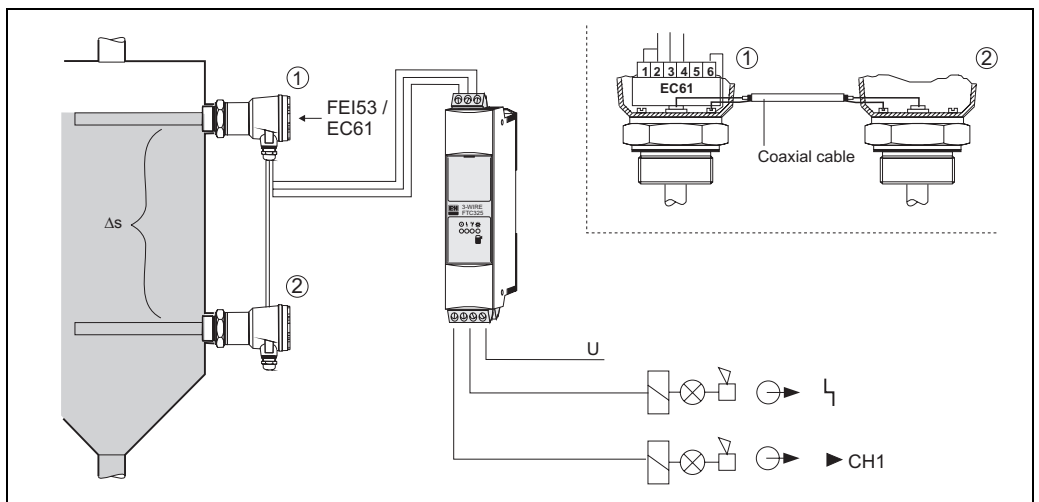

100-FTC325xx-14-06-xx-en-001

Two-point control with two fully or partially insulated probes and an electronic insert EC61 resp. FEI53. The probes are connected by a coaxial cable.

Input parameters

Measured variable	The limit signal is generated at minimum or maximum level, depending on the selection
Measuring range	The measuring range is dependent on the mounting location of the probes.
Input signal	<p>FTC325 PFM</p> <ul style="list-style-type: none"> ■ FTC325 PFM input: galvanically isolated from power supply and output ■ Type of protection: intrinsic safety [EEx ia] IIC ■ Connectable sensors: <ul style="list-style-type: none"> Liquicap M (FTI51, FTI52) with FEI57S Solicap M (FTI55, FTI56) with FEI57S Solicap S (FTI77) with FEI57S Solicap (FTC51, FTC52, FTC53)* with EC17ZS Multicap T* with EC17Z Multicap Classic* with EC16Z, EC17Z Multicap EA* with EC17Z High-temperature probes 11500**, T12656***, T12892*** with EC17Z, EC27Z Double rod probe 11304*** with EC17Z ■ Sensor's power supply: from Nivotester FTC325 PFM ■ Connecting cable: two-wire, shielded wire not required, except for strong electromagnetic interferences (see also Electromagnetic Compatibility (EMC) on page 12) ■ Cable resistance: max. 25 Ω per wire ■ Signal transmission: pulse-frequency modulation (PFM) <p>* Phase-out: 2007, ** Phase-out: 2008, *** Phase-out: 2009</p> <p>FTC325 3-WIRE</p> <ul style="list-style-type: none"> ■ FTC325 3-WIRE input: galvanically isolated from power supply and output ■ Type of protection: version for non-hazardous areas ■ Connectable sensors: <ul style="list-style-type: none"> Liquicap M (FTI51, FTI52) with FEI53S Solicap M (FTI55, FTI56) with FEI53S Solicap S (FTI77) with FEI53S Solicap (FTC51, FTC52, FTC53)* with EC61 Multicap T* with EC61 Multicap Classic* with EC61 High-temperature probes T12656,** T12892** with EC61 ■ Sensor's power supply: from Nivotester FTC325 3-WIRE ■ Connecting cable: three-wire, shielded wire not required, except for strong electromagnetic interferences (see also Electromagnetic Compatibility (EMC) on page 12) ■ Cable resistance: max. 25 Ω per wire ■ Signal transmission: voltage change is transmitted via a separate wire <p>* Phase-out: 2007, ** Phase-out: 2009</p>

Output parameters

Output signal	<p>FTC325 PFM and FTC325 3-WIRE</p> <ul style="list-style-type: none"> ■ Relay output: a potential-free change-over contact for the level alarm ■ Quiescent current fail-safe circuit: minimum/maximum fail-safe mode can be selected using the DIL switch ■ Alarm relay: potential-free change-over contact for fault indication; with the PFM version, only two contacts brought out (state type of contact NC or NO when ordering a PFM device) ■ Switching delay: 0...45 s Relay switches when covering or uncovering the probe, depending on the setting ■ Switching capacity of relay contacts: <ul style="list-style-type: none"> U~ maximum 253 V I~ maximum 2 A P~ maximum 500 VA at $\cos \varphi \geq 0.7$ U- maximum 40 V I- maximum 2 A P- maximum 80 W <ul style="list-style-type: none"> ■ Service life: at least 10^5 switching cycles at maximum contact load ■ Function indicators: light emitting diodes for operation, level alarm, fault and level signal (lights up as long as the probe is covered)
Signal on alarm	Limit relay de-energised; fault indication via red LED, alarm relay de-energised
Galvanic isolation	All input and output channels and relay contacts are provided with secure galvanic isolation from each other. In the case of simultaneous connection of the power supply circuit or the alarm relay contacts to the functional extra-low voltage, the secure galvanic isolation is guaranteed up to a voltage of 150 V AC.
Overvoltage category as per EN 61010	II
Protection class	II (double or increased insulation)

Power supply

Electrical connection

Terminal blocks

The removable terminal blocks are isolated after intrinsically safe connections (top of device) and non-intrinsically safe connections (bottom of device). Furthermore, the terminal blocks are also colour-coded. Blue is for the intrinsically safe area and grey for the non-intrinsically safe area. These distinctions allow for safe cable routing.

Sensor connection

(To the upper, blue/grey terminal blocks).

Use a usual commercial instrument cable or multi-core cable for measuring purposes for the connecting cable between the Nivotester FTC325 and the sensor. Cable resistance of maximum 25 Ω per wire.

If strong electromagnetic interferences have to be expected, e.g. from machines or radios, a screened cable must be used. Only connect the screening to the grounding connection in the sensor, not to the Nivotester.

Use of measuring cell in potentially explosive atmospheres

Compliance with the national explosion protection regulations for the design and laying of intrinsically safe signal line is mandatory.

High-reliability values for capacitance and inductance are contained in Safety Instructions XA 195F.

Connection of signal and control instruments

(To the lower, grey terminal blocks)

The relay function must be observed dependent on the level and fail-safe circuit.

If a device with high inductance (e.g. contactor, solenoid valve, etc.) is connected, a spark suppressor must be added to protect the relay contact.

Supply voltage connection

(To the lower, grey terminal blocks)

For the voltage versions, see the Ordering information on page 17.

A fuse (T 200 mA) is built into the power supply circuit, so that it is not necessary to pre-connect a fine-wire fuse. The Nivotester is equipped with reverse polarity protection.

Supply voltage

Alternating current version (AC):

- Voltage ranges: 85...253 V, 50/60 Hz

Direct current version (DC):

- Voltage range: 20...60 V
- Power supply direct current: maximum 100 mA
- Permitted residual ripple within the tolerance: $U_{ss} = \text{maximum } 2 \text{ V}$

Power consumption

AC version

maximum 6.0 VA

DC version

maximum 2.0 W (at U_{min} 20 V)

Operating conditions (installation conditions)

Installation instructions

Installation location

The Nivotester must be housed outside of hazardous areas in a cabinet. For installation outdoors, there is also a protective housing (IP65) for up to three Nivotester FTC325 available.

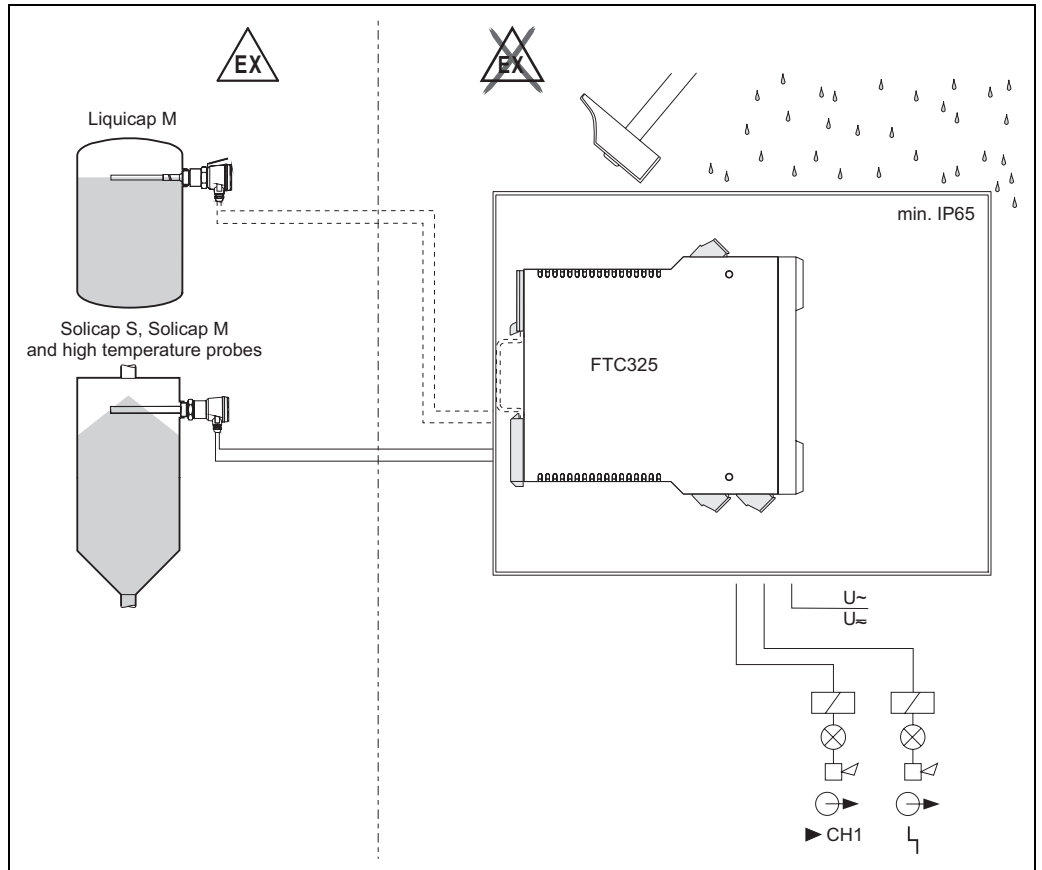

L00-FTC325xx-11-06-xx-en-001

Orientation

Vertical on DIN rail (EN 60715 TH 35).

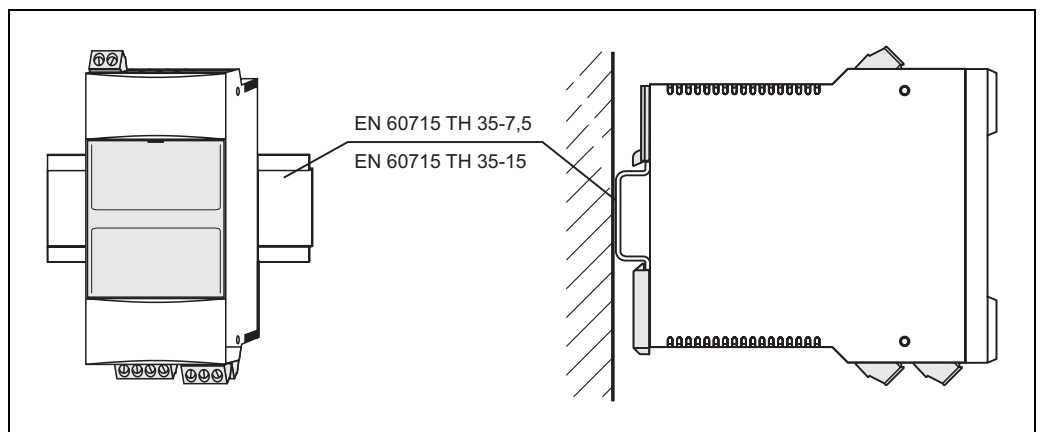

L00-FTxxxxxx-11-06-xx-xx-001

Operating conditions (environmental conditions)

Installation location	Cabinet or protective housing
Permitted ambient temperatures	<p>For single mounting</p> <ul style="list-style-type: none"> ■ -20 °C...+60 °C <p>For series mounting without lateral spacing</p> <ul style="list-style-type: none"> ■ -20 °C...+50 °C <p>Storage temperature</p> <ul style="list-style-type: none"> ■ -25 °C...+85 °C (preferably at +20 °C) <p>Installation in protective housing</p> <ul style="list-style-type: none"> ■ -20 °C...+40 °C ■ No more than three Nivotesters can be installed into one protective housing
	<p> Caution! The devices should be installed in locations which are protected from direct solar radiation, weather and impacts. This is of particular importance in hot climates.</p>
Climatic and mechanical application class	<p>3K3 In acc. with DIN EN 60721-3-3</p> <p>3M2 In acc. with DIN EN 60721-3-3</p>
Degree of protection	IP20
Electromagnetic compatibility (EMC)	<p>Interference Emission to EN 61326; Electrical Equipment Class B</p> <p>Interference Immunity to EN 61326; Annex A (Industrial) and NAMUR Recommendation NE 21 (EMC)</p>

Mechanical construction

Design, dimensions

- Housing: row housing made of plastic
- Mounting: on DIN rail as per EN 60715 TH 35-7.5 or EN 60715 TH 35-15
- Degree of protection as per EN 60529; IP20

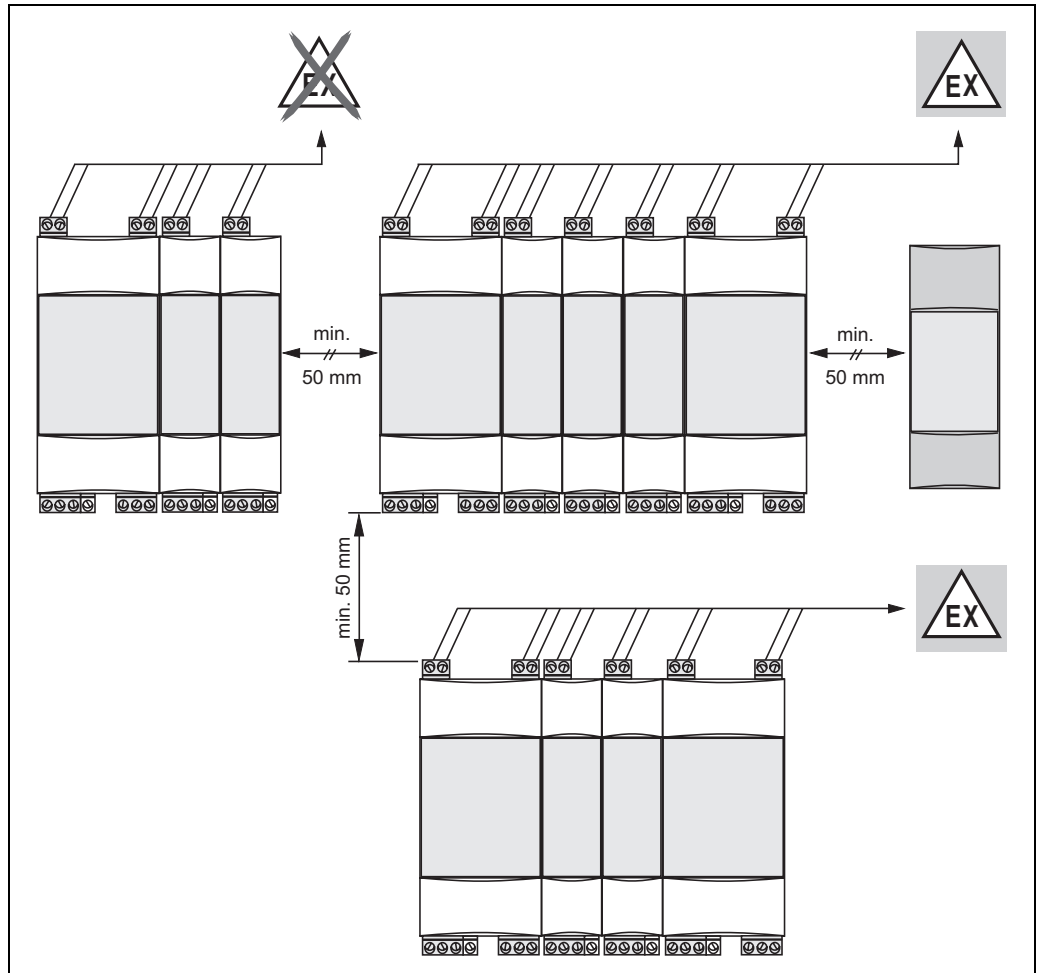

L00-FTxxxxxx-06-06-xx-xx-002

Dimensions: 3-WIRE PFM

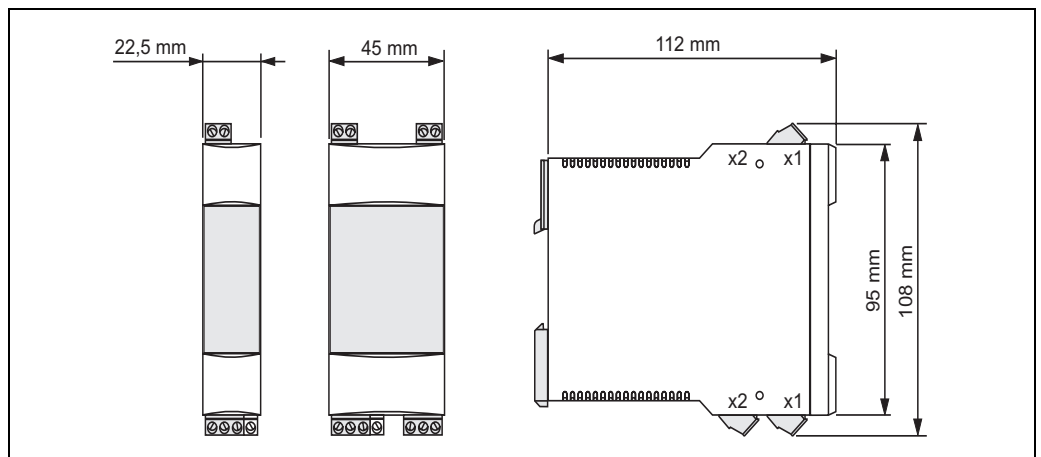

L00-FTxxxxxx-06-06-xx-xx-004



Note!
100 mm = 3.94 in

Weight approx. 250 g

Materials

Housing

- Polycarbonate
Colour: light grey, RAL 7035

Front cover

- Polypropylene PPN
Colour: blue

Fixing bracket (for securing on the DIN rail)

- Polyamide PA6
Colour: black, RAL 9005

Terminals

Nivotester FTC325 PFM

- 2 screw terminals: probe supply
- 3 screw terminals: limit relay
- 2 screw terminals: alarm relay
- 2 screw terminals: power supply

Nivotester FTC325 3-WIRE

- 3 screw terminals: probe supply + signal
- 4 screw terminals:
 - 3 limit value relay
 - 1 for contact 3 of the alarm relay
- 4 screw terminals:
 - 2 AC/DC supply (power supply)
 - 2 alarm relay

Connection cross-section

maximum 1 x 2.5 mm or 2 x 1.5 mm

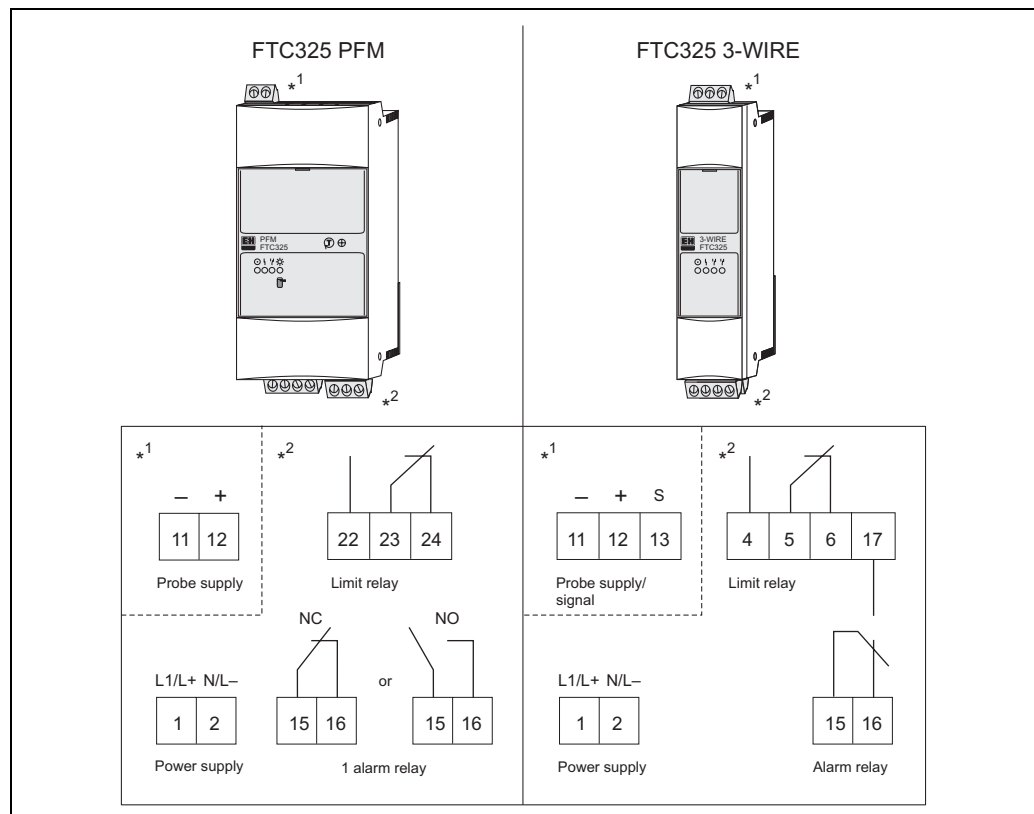

L00-FTC325xx-04-06-xx-en-001

User interface

Display elements

1. red light emitting diode: fault indication
2. green light emitting diode: standby
3. yellow light emitting diode (left): "limit relay energised"
4. yellow light emitting diode (right): "probe uncovered/covered" level indication independent of the selected fail-safe circuit

Operating elements

Operating concept

On-site configuration with switches behind the folding front panel

Nivotester FTC325 PFM

- A Calibration for covered or uncovered probe
- B DIL switch 1-4: switching delay (3 s, 6 s, 12 s, 24 s) = max. 45 s
DIL switch 5: delay when covering or uncovering the probe
DIL switch 6: no function
DIL switch 7: min./max fail-safe mode
DIL switch 8: no function
- C Switch point shift for build-up compensation (16-stage)
- D Correction key (green)
- E Calibration key (red)

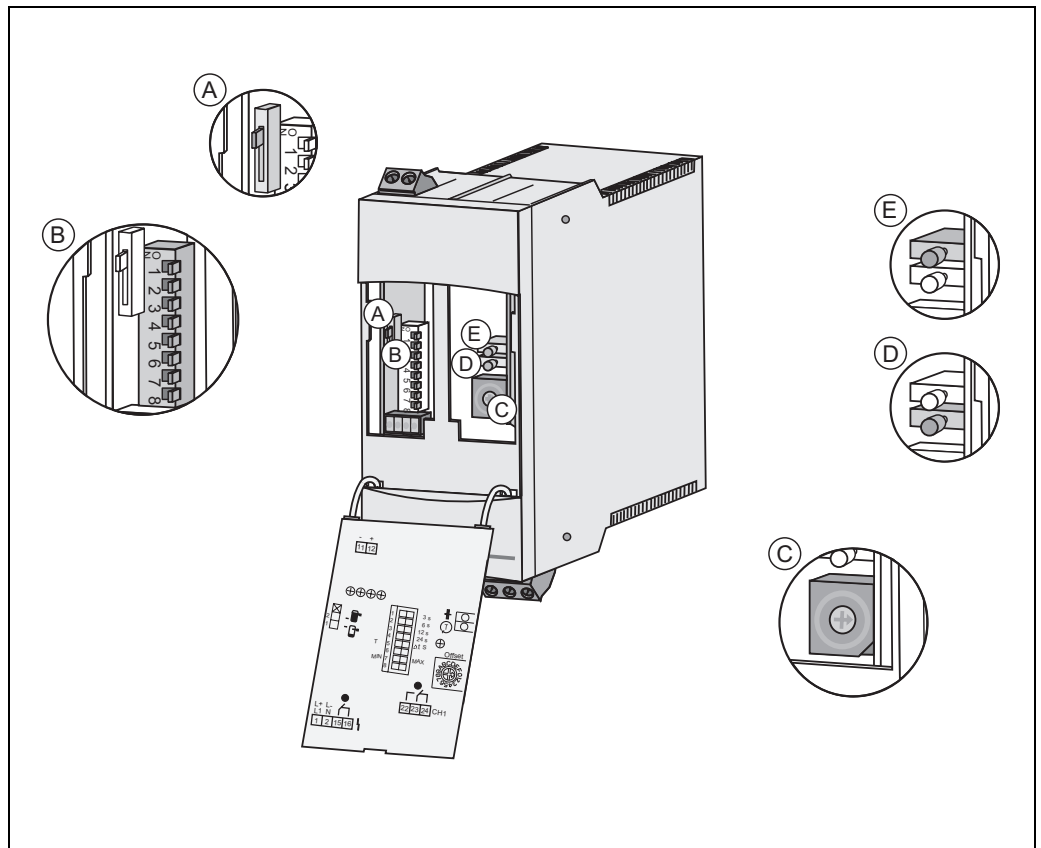

L00-FTC325xx-03-06-06-xx-001

Operating elements

Nivotester FTC325 3-WIRE

- A Calibration for covered or uncovered probe
- B DIL switch 1-4: switching delay (3 s, 6 s, 12 s, 24 s) = max. 45 s
DIL switch 5: delay when covering or uncovering the probe
DIL switch 6: min/max fail-safe mode
- C Switch point shift for build-up compensation (infinitely variable)
- E Calibration key (red)

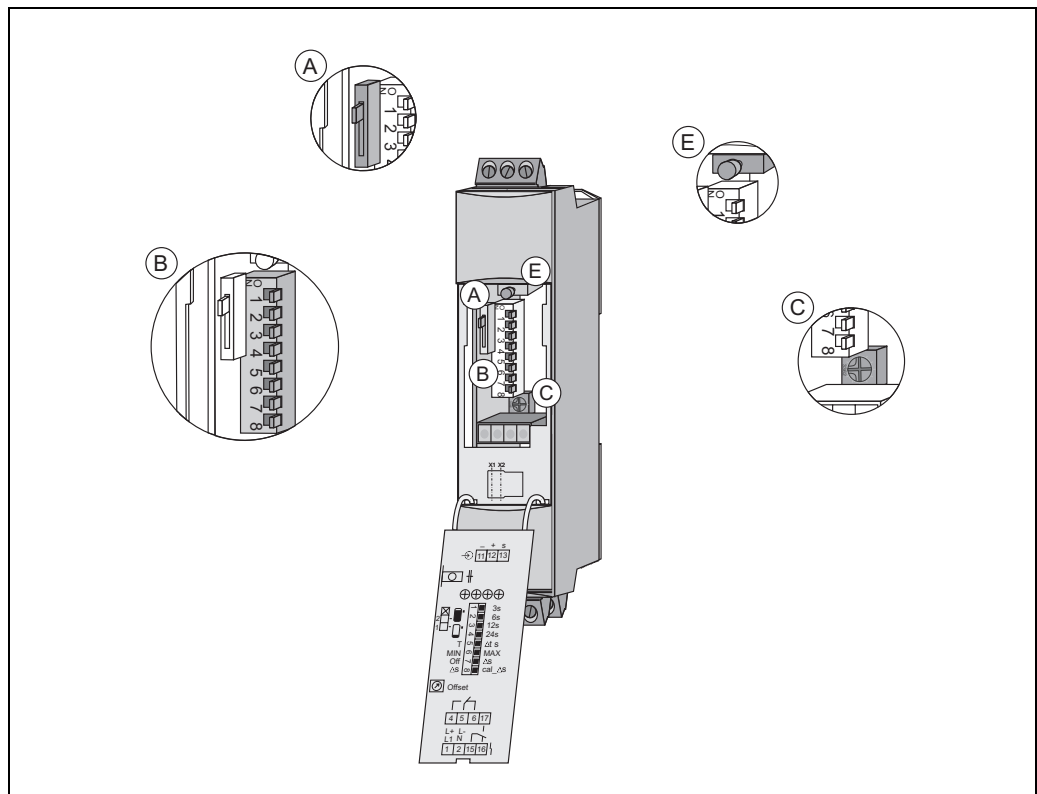

100-FTC325xx-03-06-06-xx-002

Certificates and approvals

CEmark	The Nivotester meets all the statutory requirements arising from EC directives. Endress+Hauser confirms the successful testing of the device by affixing the CE-symbol.
Ex approval	Endress+Hauser Sales Centers provide information about the currently available versions for use in hazardous areas (ATEX EEx ia IIC; FM IS; CSA IS) All the relevant data for explosion protection is contained in separate Ex documentation (see: Supplementary Documentation), which can be requested.
Type of protection	[EEx ia] IIC (only for FTC325 PFM)
Overspill protection	WHG (only for FTC325 PFM)
Other standards and regulations	Other standards and regulations which were complied with during the conception and development of the Nivotester FTC325. <ul style="list-style-type: none">■ EN 60529 Degrees of protection through housing (IP code)■ EN 61010 Safety regulations for electrical control and instrumentation devices and laboratory instruments■ EN 61326 Interference emission (Equipment Class B), interference immunity (Annex A - Industrial)

Ordering information

Nivotester FTC325 PFM

10	Certificates	
	A	For non-hazardous areas
	B	For non-hazardous areas, WHG
	C	ATEX II (1) GD (EEx ia) IIC, WHG
	D	FM IS Cl.I,II,III Div1 Group A-G
	E	CSA IS Cl.I,II,III Div1 Group A-G
	F	CSA General Purpose
	Y	Special version
20	Input	
	1	2-wire PFM rail mounting 45 mm
	9	Special version
30	Power supply	
	A	Power supply 85... 253 V AC, 50/60 Hz
	B	Power supply 20... 30 V AC / 20... 60 V DC
	Y	Special version
40	Output	
	1	1 x level SPDT + 1 x alarm SPST NC (normally closed)
	2	1 x level SPDT + 1 x alarm SPST NO (normally open)
	9	Special version
50	Additional options	
	1	Additional options not selected
	9	Special version
995	Marking	
	1	Tagging (TAG)
FTC325 PFM		Complete product name

Nivotester FTC325 3-WIRE

10	Certificates	
	A	For non-hazardous areas
	F	CSA General Purpose
	Y	Special version
20	Input	
	2	3-WIRE analogue rail mounting 22.5 mm
	9	Special version
30	Power supply	
	A	Power supply 85... 253 V AC, 50/60 Hz
	B	Power supply 20... 30 V AC / 20... 60 V DC
	Y	Special version
40	Output	
	3	1 x level SPDT + 1 x alarm SPDT
	9	Special version
50	Additional options	
	1	Additional options not selected
	9	Special version
995	Marking	
	1	Tagging (TAG)
FTC325 3-WIRE		Complete product name

Accessories

Protective housing

The protective housing in protection class IP66 is equipped with an integrated DIN rail and closed by a transparent cover, which can also be lead-sealed.

Dimensions:

W: 180 / H: 182 / D: 165

Technical Data:

- Ingress protection (EN 60529): IP66
- Lower housing section: fibre-glass reinforced polycarbonate, grey
- Upper housing section: polycarbonate, transparent
- Cover screws: PA, 4 pieces, 2 of which are sealing
- Seal: PU seal
- Top-hat rail (EN 50022): galvanized
- Cable entries: 5 pieces M 20x1,5
- Part number: 52010132

Supplementary Documentation

System Information (SI)

- Capacitance level measurement
SI001F/00

Technical Information (TI)**Capacitance level probes**

- Liquicap M
FTI51, FTI52
TI417F/00
- Solicap M
FTI55, FTI56
TI418F/00
- Solicap S
FTI77
TI433F/00

Protective housing

- Protective housing
TI367F/00

Operating manual (KA)

- Nivotester
FTC325 PFM
KA221F/00
- Nivotester
FTC325 3-WIRE
KA222F/00

Certificates (only for PFM)**ATEX:**

- Nivotester
FTC325, FTC625
XA 195F/00

WHG (DIBt):

- Nivotester
FTC325
ZE 211F/00

Instruments International

Endress+Hauser
Instruments International AG
Kaegenstrasse 2
4153 Reinach
Switzerland

Tel. +41 61 715 81 00
Fax +41 61 715 25 00
www.endress.com
info@ii.endress.com

Endress+Hauser 

People for Process Automation

TI380F/00/EN/05.10
71115361
CCS/FM+SGML 6.0 ProMoDo



71115361