



Level



Pressure



Flow



Temperature

Liquid
Analysis

Registration

Systems
Components

Services



Solutions

Technical Information

Minicap FTC260, FTC262

Capacitive Limit Detection

Compact switch for limit detection with active build-up compensation; No calibration necessary

Version available for dust explosion areas



Applications

Minicap is designed for limit detection of light bulk solids, with a grain size up to max. 30 mm and a dielectric constant $\epsilon_r \geq 1.6$, e.g. grain products, flour, milk powder, animal feed, cement, chalk or gypsum.

Versions:

- Minicap FTC260 (left): with 140 mm rod probe, with FDA listed material; for bulk solids and liquids
- Minicap FTC262 (right): with max. 6 m rope probe; for bulk solids
- Relay output (potential-free change-over contact / SPDT) with AC or DC power
- PNP output with three-wire DC power

Your Benefits

- Complete unit consisting of the probe and electronic insert:
 - simple mounting
 - no calibration on start-up
- Active build-up compensation
 - accurate switch point even with heavy build-up on the probe
 - high operational safety
- Mechanically rugged
 - no wearing parts
 - long operating life
 - no maintenance
- The rope probe of the Minicap FTC262 can be shortened
 - optimum matching to the measuring point in the silo
 - less stocks required

Table of contents

Function and system design	3	Human interface	14
General Information	3	Display elements	14
Measuring principle	3	Operating elements	14
Measuring System	6	Certificates and approvals	14
Input	7	CE approval	14
Measured variable	7	Ex approval	14
Measuring range	7	Overspill protection FTC260	14
Output	7	Ordering information	15
Output signal	7	Product structure FTC260	15
Signal on alarm	7	Product structure FTC262	16
Switching delay when free or covered	7	Accessories	17
Overvoltage category	7	Adapter	17
Protection class	7	Transparent cover	17
Power supply	7	Rope shortening set	17
Electrical connection	7	Supplementary documentation	17
Supply voltage	8	Operating manual (BA)	17
Terminal compartment	8	Safety instructions (XA)	17
Performance characteristics	9		
Reference operating conditions	9		
Hysteresis	9		
Switch point	9		
Power up response	9		
Long-term drift	9		
Influence of medium temperature	9		
Operating conditions	9		
Installation	9		
Installation instructions FTC260	10		
Installation instructions FTC262	11		
Environment	12		
Ambient temperature range T1	12		
Ambient temperature limits	12		
Storage temperature	12		
Climate class	12		
Degree of protection	12		
Shock resistance	12		
Vibrational resistance	12		
Electromagnetic compatibility	12		
Process	12		
Process temperature range T2	12		
Process temperature limits	12		
Process pressure range pe	12		
Temperature diagrams	12		
Mechanical construction	13		
Design, Dimensions (in mm)	13		
Material for wetted parts	14		
Process connections	14		
Housing	14		

Function and system design

General Information

Technical specifications to DIN 19259

Measuring principle

Limit Detection

A metal plate at the end of the probe, within the insulation, and the integrated counter-electrode together with the surroundings combine to form the two electrodes of a capacitor.

If the probe is covered or free of material, then the capacitance changes and the Minicap switches.

Active Build-up Compensation

The Minicap detects build-up on the probe and compensates for its effects so that the switch point is always accurate. The effects of build-up compensation depend on:

- the thickness of the build-up on the probe,
- conductivity of the material,
- the sensitivity setting on the electronic insert.

Setting the Sensitivity

The Minicap is so calibrated at the factory that it correctly switches in most cases.

Greater sensitivity can be set using a multi-pole switch on the electronic insert. This is only necessary, however, if there is very strong build-up on the probe, or if the dielectric constant of the material ϵ_r is very small.

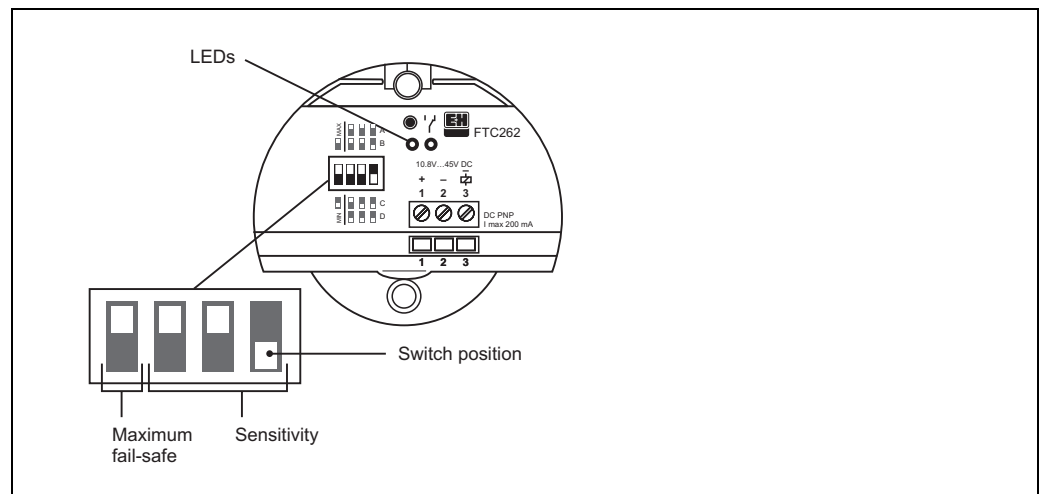

Factory setting on switches

100-FTC20xxx-15-06-xx-en-001

Function Range

There is a loose relationship between the dielectric constant ϵ_r and density ρ of the material. However, this depends on the solid.

The table on the left indicates whether the Minicap can be used or if application limits are exceeded.

Grain, seed, legumes and their products			
Examples	ρ in g/l (approx.)	ϵ_r (approx.)	Function
Rice	770	3.0	yes
Cornstarch (packed)	680	2.6	yes
Flour (wheat)	580	2.4	yes
Corn grist	500	2.1	yes
Sunflower seeds	380	1.9	yes
Noodles	370	1.9	yes
Bran (wheat)	250	1.7	yes
Popcorn	30	1,1	no
Minerals, inorganic materials			
Cement	1050	2.2	yes
Plaster	730	1.8	yes
Chalk (packed)	540	1.6	(yes)
Chalk (loose)	360	1.4	no
Plastics			
ABS granulate	630	1.7	yes
PA granulate	620	1.7	yes
PE granulate	560	1.5	no
PVC powder	550	1.4	no
PU-PU dust	80	1.1	no
Grey background: Application limits of Minicap exceeded. Recommendation: Soliphant FTM to be used.			

In general:

If the dielectric constant of the solid is not known, then the density (apparent weight) of the solid is a deciding factor.

Under normal conditions the Minicap functions in foodstuffs with a density of 250 g/l and above or in plastic or mineral materials with a density of 600 g/l and above.

Minimum/Maximum Fail-Safe Mode











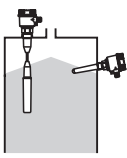
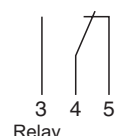
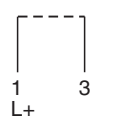

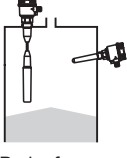
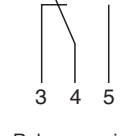
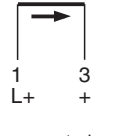
The Minicap FTC260 can be set to minimum or maximum fail-safe mode (see following table).

*AC or DC version with relay output
(potential-free change-over contact):*

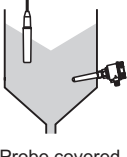
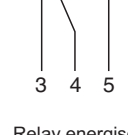
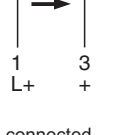
- Maximum fail-safe mode:
The relay is de-energised when the probe is covered or the power supply fails.
- Minimum fail-safe mode:
The relay is de-energised when the probe is free or the power supply fails.

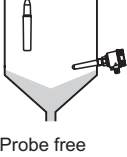
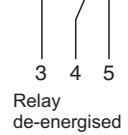
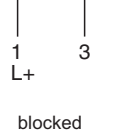
DC version with PNP output:

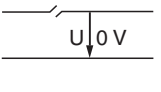
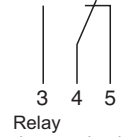
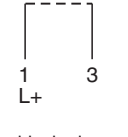
- Maximum fail-safe mode:
The switch output is blocked when the probe is covered or the power supply fails.
- Minimum fail-safe mode:
The switch output is blocked when the probe is free or the power supply fails.

Switch position	Level	Relay output SPDT	Transistor output PNP	Red LED for switching status	Green LED for stand-by
 Maximum fail-safe mode	 Probe covered	 Relay de-energised	 blocked		
	 Probe free	 Relay energised	 connected		
 Minimum fail-safe mode	 Probe covered	 Relay energised	 connected		
	 Probe free	 Relay de-energised	 blocked		
 Power failure		 Relay de-energised	 blocked		

L00-FTC26xxx-15-06-xx-en-002

Selecting the switch position and function

Measuring System

Minicap is an electronic switch. The complete measuring system consists of:

- the Minicap FTC260 or FTC262
- a power supply and
- controllers, switching devices, signal transmitters (e.g. lamps, horns, PCS, PLC, etc.)

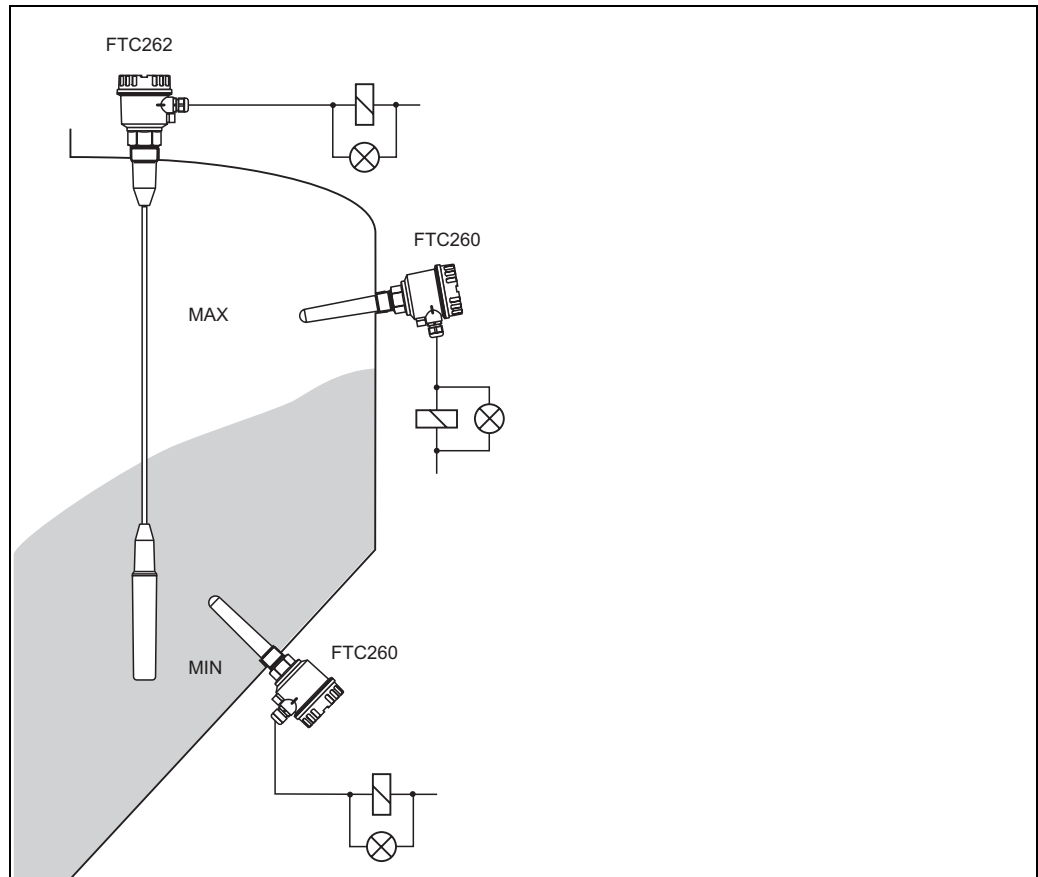

Limit detection in silos containing solids

Input

Measured variable	Limit detection
Measuring range	<ul style="list-style-type: none"> ■ FTC260: $\varepsilon_r \geq 1.6$ ■ FTC262: $\varepsilon_r \geq 1.5$

Output

Output signal	<ul style="list-style-type: none"> ■ DC, PNP transistor output: Switching: PNP I_{\max} 200 mA – overload and short circuit protection – residual voltage at transistor at $I_{\max} < 2.9$ V ■ AC / DC, Relay output: Contact: change-over, potential-free $U_{\sim \max}$ 253 V, $I_{\sim \max}$ 4 A (AC) $P_{\sim \max}$ 1000 VA, $\cos \varphi = 1$ $P_{\sim \max}$ 500 VA, $\cos \varphi > 0.7$ $I_{\overline{\sim} \max}$ 4 A up to $U_{\overline{\sim}}$ 30 V (DC) $I_{\overline{\sim} \max}$ 0.2 A up to $U_{\overline{\sim}}$ 253 V (DC)
Signal on alarm	<ul style="list-style-type: none"> ■ DC, PNP transistor output: < 100 μA ■ AC / DC, Relay output: relay de-energised
Switching delay when free or covered	<ul style="list-style-type: none"> ■ FTC260: 0.5 s ■ FTC262: 0.8 s

Overvoltage category	Category III (EN 61010)
-----------------------------	-------------------------

Protection class	Protection class to EN 61010-1 <ul style="list-style-type: none"> ■ FTC260: Class II ■ FTC262: Class I
-------------------------	--

Power supply

Electrical connection	<p>To ensure that the Minicap operates safely and without electrical interference, it must be connected to an earthed silo with metal or reinforced concrete walls.</p> <p>For silos made of non-conductive materials, the external earth wire of the Minicap must be connected to a conductive and earthed component which is earthed near to the silo.</p> <p>The protective earth can be connected to the internal earth terminal of the Minicap.</p> <p>Connections can be made with standard instrument cabling.</p> <p>See TI241F/00/EN for information on EMC (testing procedures, installation).</p> <p>Connect the potential matching lead (PAL) when using in dust explosion hazardous areas.</p> <p>Note national regulations!</p>
------------------------------	---

Minicap AC or DC connection and relay output

- F1: Fine-wire fuse to protect the relay contact, dependent on the connected load
- F2: Fine-wire fuse, 500 mA
- M: Earth connection to silo or metal components on silo
- E: Earth

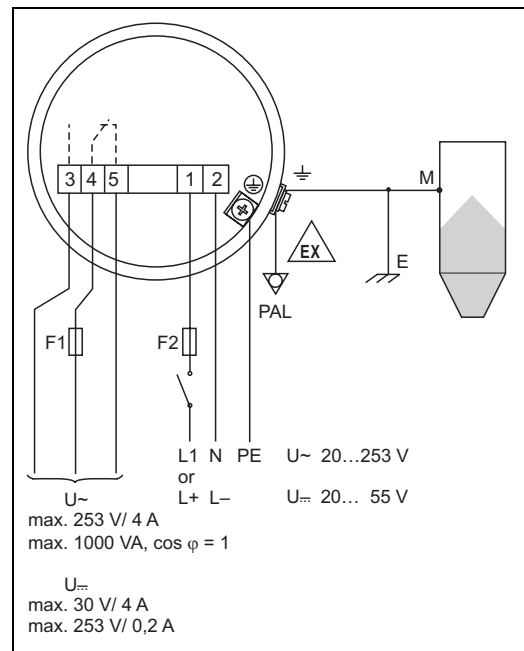

L00-FTC26xxx-04-06-xx-xx-001

No ground lines (PE) or potential matching lines (PAL) are required with Minicap FTC260.

Minicap with three-cable DC connection; Transistor output PNP

- F: Fine-wire fuse, 500 mA
- R: Connected load, e.g. PLC, PCS, relay
- M: Earth connection to silo or metal components on silo
- E: Earth

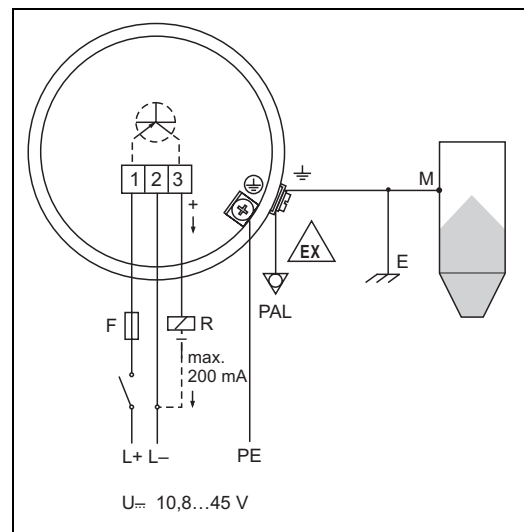

L00-FTC26xxx-04-06-xx-xx-001

Minicap is protected against reverse polarity. The green LED for standby goes out if the connections are reversed.

No ground lines (PE) or potential matching lines (PAL) are required with Minicap FTC260.

Supply voltage

- DC, PNP transistor output:
 - U= 10.8...45 V
 - transient pulses to 55 V
 - current consumption max. 30 mA
 - reverse polarity protected
- AC / DC, Relay output:
 - U~ 20...253 V
 - or U= 20...55 V
 - current consumption max. 130 mA

Terminal compartment

- Stranded wires max. 1.5 mm² in end sleeves
- Electric wire max. 2.5 mm²

Performance characteristics

Reference operating conditions	(for plastic vessels) <ul style="list-style-type: none"> ■ Ambient temperature: 23 °C ■ Medium temperature: 23 °C ■ Medium pressure p_e: 0 bar ■ Medium: dielectric constant $\epsilon_r = 2.6$ ■ Conductivity: $< 1 \mu\text{S}$ ■ Sensitivity setting: C
Hysteresis	<ul style="list-style-type: none"> ■ FTC260: Horizontal 4 mm, Vertical 7 mm ■ FTC262: Vertical 5 mm
Switch point	<ul style="list-style-type: none"> ■ FTC260: Horizontal: centre of probe -5 mm, Vertical: 40 mm above probe tip ■ FTC262: Vertical: 35 mm above probe tip
Power up response	<ul style="list-style-type: none"> ■ FTC260: Correct switching after max. 1.5 s ■ FTC262: Correct switching after max. 2 s
Long-term drift	<ul style="list-style-type: none"> ■ FTC260: Horizontal 3 mm, Vertical 6 mm ■ FTC262: Vertical 6 mm
Influence of medium temperature	<ul style="list-style-type: none"> ■ FTC260: Depending on material to be measured ■ FTC262: Depending on material to be measured

Operating conditions

Installation

Silo Material

The Minicap can be installed in a wide range of silos made of different materials (e.g. metal, plastic, concrete).

Mounting Point

Note the angle of the material mounds and the outlet funnel when determining the mounting point or probe length of the FTC262.

The Minicap switches when the probe tip is covered by a few centimeters of material or when it is free.

Material flow should not be directed at the probe.

Installation instructions FTC260

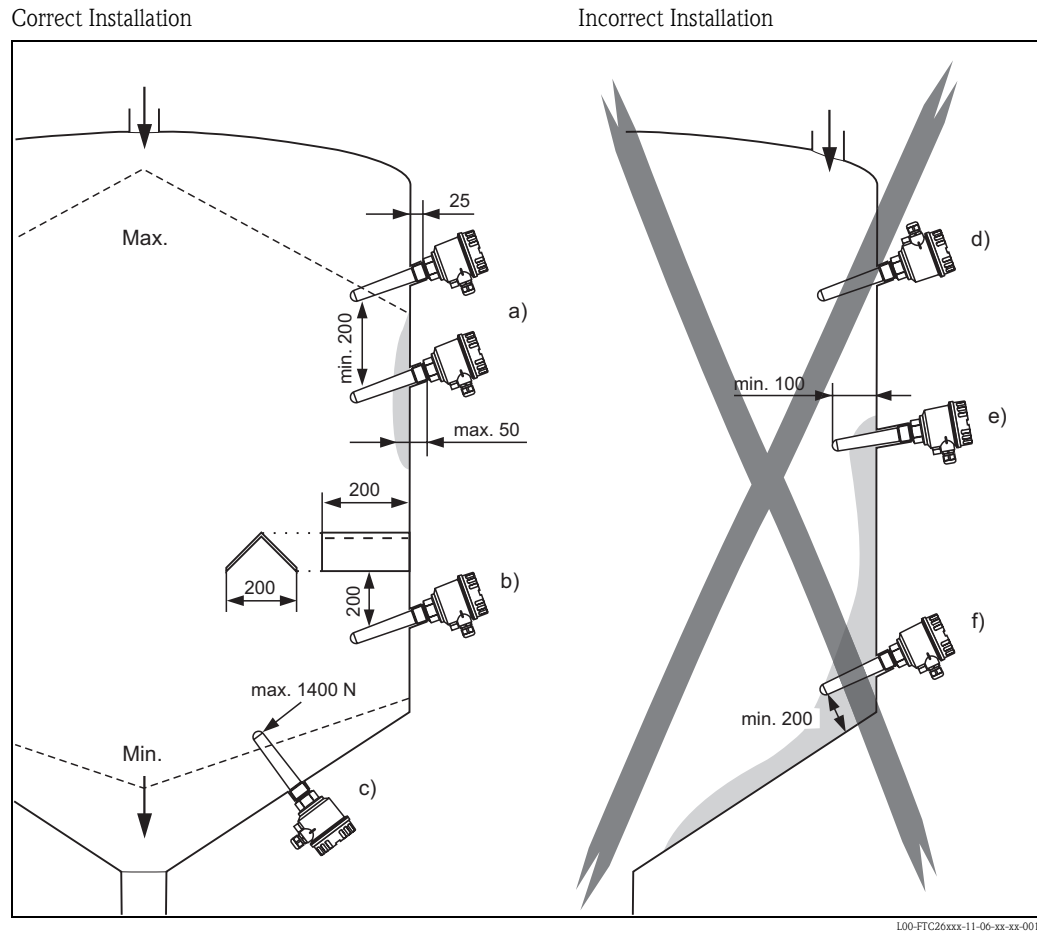

General information and recommendations for installing the Minicap FTC260 limit switch
(Dimensions in mm)

Correct Installation

- Minimum distance:**
To prevent mutual interference with the FTC260, the probes must be at least 200 mm from each other.
- Mounting point:**
The tip of the probes must point slightly downwards so that the material can slide off more easily.
The protective cover protects the probe rod from collapsing mounds or mechanical strain at the outflow when the Minicap FTC260 is set to minimum detection.
- Mechanical load:**
The maximum lateral load on the probe rod must be taken into account when used for minimum detection. It should therefore only be used for minimum detection with loose materials that have good flow characteristics.

Incorrect Installation

- The probe can be damaged by the inflowing material and cause faulty switching.
Cable gland pointed upwards can allow moisture to enter.
- Threaded socket too long with material build-up on the silo wall.
(less than the minimum mounting depth of 100 mm).
- Mounted near build-up in the silo.
The probe tip is too near to a silo wall (less than a minimum distance of 200 mm).

**Installation instructions
FTC262**

Correct Installation

Incorrect Installation

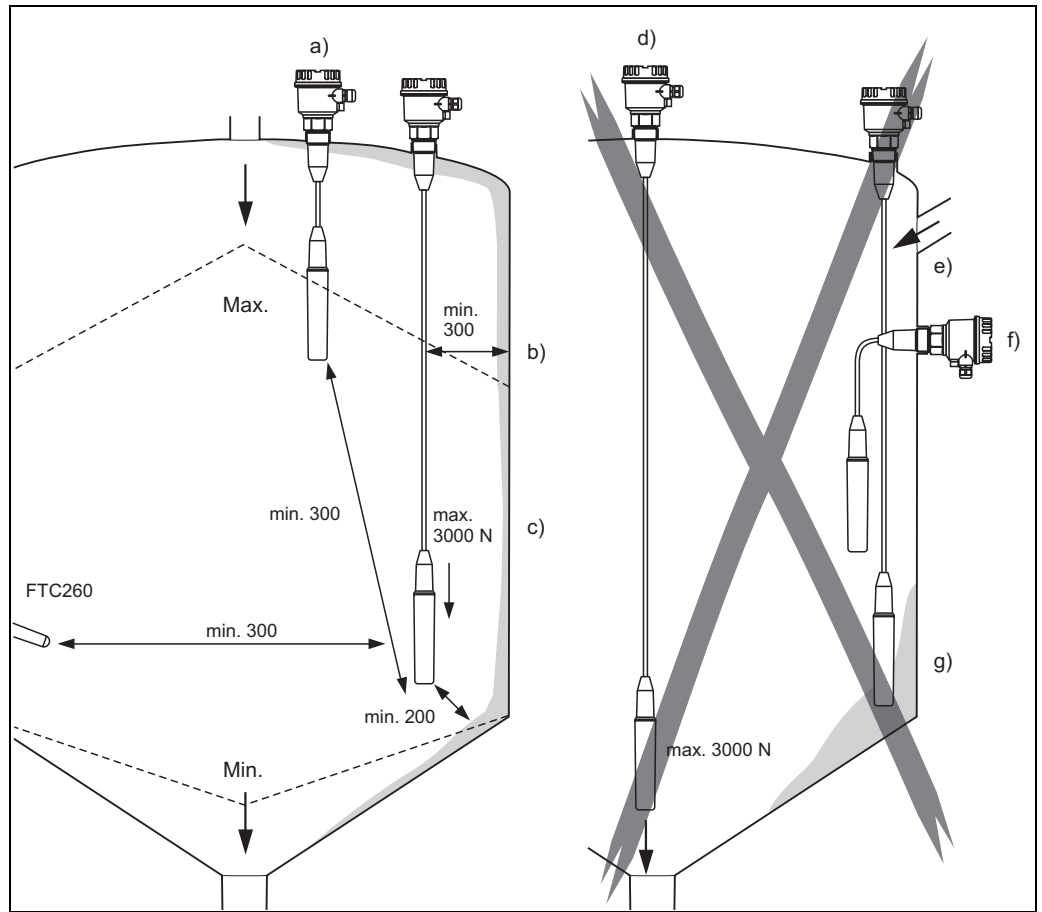

*General information and recommendations for installing the Minicap FTC262 limit switch
(Dimensions in mm)*

Correct Installation

- a. Minimum distances:
Sufficient distance from the material filling curtain and the other probe.
- b. Mounting point:
Do not install in the centre of the outlet cone. Ensure there is sufficient distance from the silo wall and from material build-up on the wall.
- c. Mechanical load:
Note the tensile strain on the probe rope and the strength of the silo roof when used for minimum detection.
Very high tensile forces may occur at the material outlet especially with heavy, powdery bulk materials which tend to form build-up. These forces are significantly greater over the outlet than at the silo wall. For minimum detection Minicap FTC262 should only be used for light, easily flowing solids, and that do not tend to form build-up.

Incorrect Installation

- d. In the centre of the material outflow; the high tensile forces at this point may tear off the probe or damage the silo roof.
- e. The probe may be damaged by inflowing material.
- f. Mounted laterally
- g. Too near silo wall; when swinging gently the probe can hit the wall or touch any build-up which may have formed. This can result in error switching

Environment

Ambient temperature range <i>T1</i>	-40...+70 °C (-40...+160 °F) (...+60 °C, Dust-Ex version] (see the temperature diagrams)
Ambient temperature limits	-40...+80 °C (-40...+180 °F) (...+60 °C, Dust-Ex version] (see the temperature diagrams; grey background)
Storage temperature	-40...+80 °C (-40...+180 °F)
Climate class	IEC 68 part 2-38
Degree of protection	IP66; NEMA 4X
Shock resistance	Probe: 7 J
Vibrational resistance	EN 60068-2-64 (IEC 68-2-64), 20...2000 Hz, spectral rate of velocity 0.5, 100 min per axis
Electromagnetic compatibility	Interference Emission to EN 61326, Electrical Equipment Class B Interference Immunity to EN 61326, Annex A (Industrial) and NAMUR Recommendation NE 21 (EMC) See TI241F/00/EN for general instructions regarding the EMC test conditions for E+H instruments.

Process

Process temperature range <i>T2</i>	<ul style="list-style-type: none"> ■ FTC260: -40...+120 °C (-40...+250 °F) (...+80 °C, Dust-Ex version) ■ FTC262: -40...+70 °C (-40...+160 °F) (see the temperature diagrams)
Process temperature limits	<ul style="list-style-type: none"> ■ FTC260: -40...+130 °C (-40...+270 °F) (...+80 °C, Dust-Ex version) ■ FTC262: -40...+80 °C (-40...+180 °F) (see the temperature diagrams; grey background)
Process pressure range p_e	<ul style="list-style-type: none"> ■ FTC260: -1...+25 bar (-14,5...+360 psi) ■ FTC262: -1...+6 bar (-14,5...+90 psi)

Temperature diagrams

FTC260

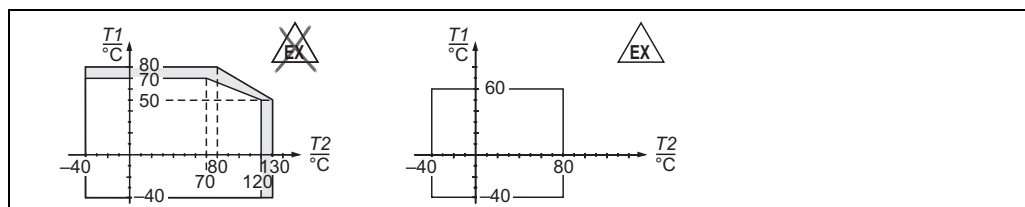

L00-FTC26xxx-05-06-xx-xx-001

FTC262

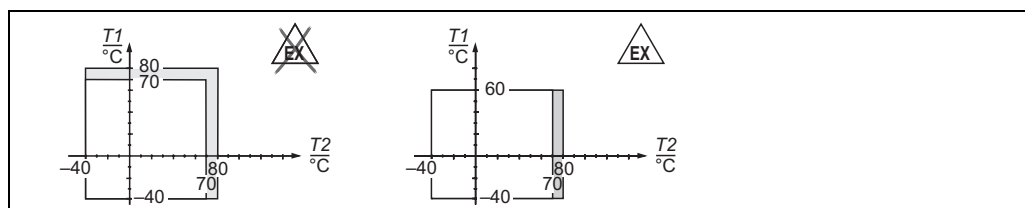

L00-FTC26xxx-05-06-xx-xx-002

Mechanical construction

Design, Dimensions (in mm)

Minicap FTC260

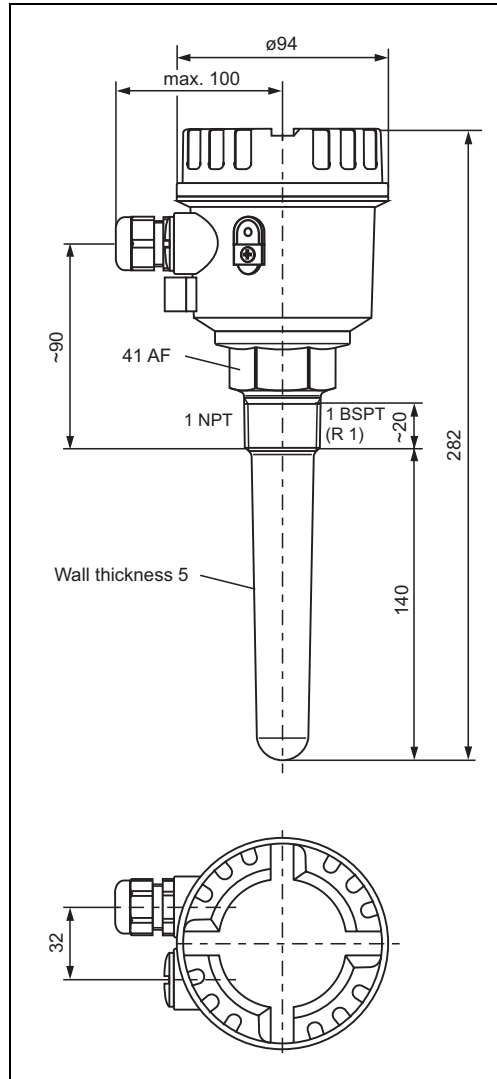

L00-FTC26xxx-06-06-xx-en-001

Adapter for FTC260

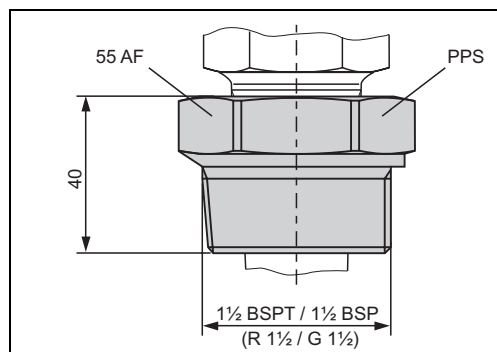

L00-FTC26xxx-06-06-xx-en-003

Probe length tolerances:

Probe length L	Tolerances
bis 1000 mm	+0, -10 mm
bis 3000 mm	+0, -20 mm
bis 6000 mm	+0, -30 mm

Minicap FTC262

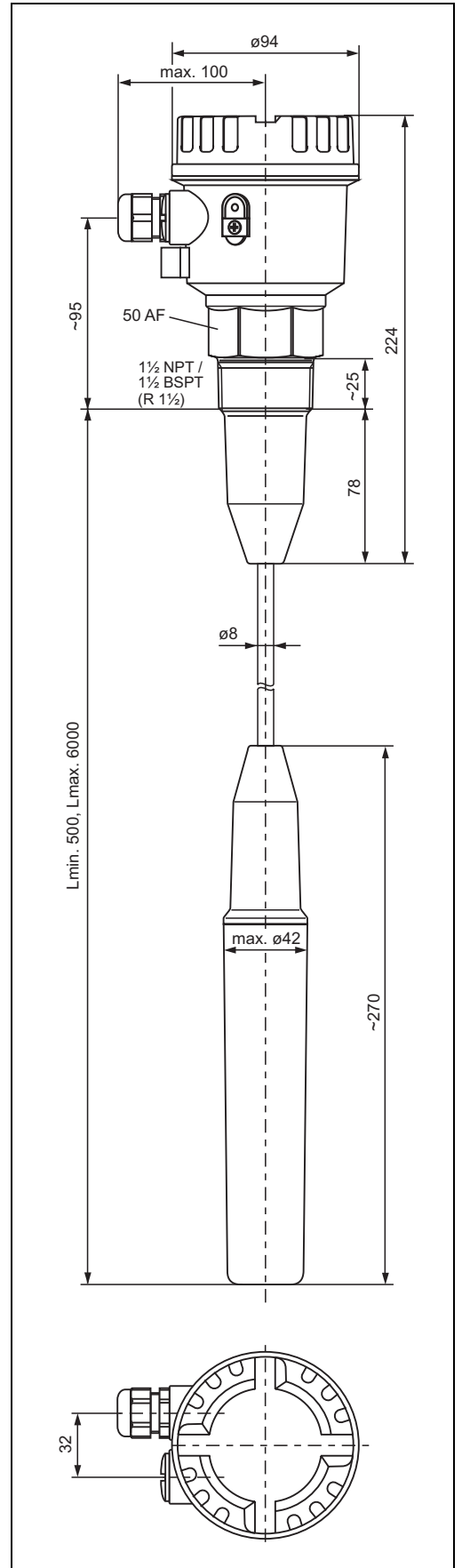

L00-FTC26xxx-06-06-xx-en-002

Material for wetted parts

- Probe rod FTC260: PPS = Polyphenylene sulphide (glass fibre content approx. 40%), FDA listed
- Probe length:
FTC260: 140 mm,
FTC262: min. 500 mm, max. 6000 mm
- Flexural strength FTC260: 1400 N (at probe tip)
- Probe rope FTC262: Surface in High Density PE over steel coating
- Other probe parts FTC262: PPS = Polyphenylene sulphide (glass fibre content approx. 40 %)
- Tensile strength F of FTC262: Max. 3000 N up to 40 °C, max. 2800 N at 80 °C



L00-FTC26xxx-05-06-xx-xx-003

Process connections

Threaded boss:

- FTC260: – 1 BSPT (R 1, ISO 7/1);
Adapter for 1½ BSPT and 1½ BSP (G 1½) see accessories
– 1 NPT, ANSI B 1.20.1;
Adapter for 1¼ NPT see accessories
- FTC262: – 1½ BSPT (R 1½, ISO 7/1)
– 1½ NPT, ANSI B 1.20.1

Housing

Housing F14: Polyester PBT-FR, IP66

Human interface

Display elements

- Green LED: stand-by
- Red LED: switch status

Operating elements

Switch on electronic insert

- switching between minimum and maximum fail-safe mode
– sensitivity setting
(depends on the dielectric constant ϵ_r and build-up).
A sensitivity adjustment is normally not required (see section "Measuring principle")

Certificates and approvals

CE approval

In attaching the CE Mark, Endress+Hauser confirms that the device conforms to all relevant EU directives.

Ex approvalATEX, FM, CSA
See section "Product structure"**Overspill protection FTC260**

DIBt, General design approval

Ordering information

Product structure FTC260

10	Approval			
	A	Non-hazardous area		
	D	Non-hazardous area, WHG		
	B	ATEX II 1/3 D		
	U	CSA, General purpose		
	S	CSA, DIP	Cl. II	Gr. E-G, Cl. III
	J	FM, DIP	Cl. II, III	Gr. E-G, T5
2	NEPSI DIP			
Y	Special version			
20	Process connection			
	A	Thread	DIN2999	R 1, PPS
	B	Thread	ANSI	NPT 1, PPS
Y	Special version			
30	Switch output			
	2	3-wire	PNP	10.8...45 V DC
	4	Relay	20...253 V AC / 20...55 V DC	
9	Special version			
40	Housing, Cable entry			
	D	F14 Polyester	IP66	Gland M20
	B	F14 Polyester	IP66	Thread NPT ½
	C	F14 Polyester	IP66	Thread G ½
Y	Special version			
50	Additional option			
	1	Basic version		
	2	Transparent cover		
9	Special version			
995	Marking			
	1	Tagging (TAG)		
FTC260	Product designation			

Product structure FTC262

10	Approval			
	A	Non-hazardous area		
	B	ATEX II 1/3 D		
	U	CSA, General purpose		
	S	CSA, DIP	Cl. II, III	Gr. G+coal dust Cl. III
	J	FM, DIP	Cl. II, III	Gr. E-G, T5
	Y	Special version		
20	Process connection			
	A	Thread	EN10226	R 1 ½, PPS
	B	Thread	ANSI	NPT 1 ½, PPS
	Y	Special version		
30	Probe length, L=500...6000 mm (20...236 inch)			
	1	... mm L (500...6000 mm)	steel	HD-PE insulated
	2	... inch L (20... 236 inch)	steel	HD-PE insulated
	3	1500 mm (59 inch)	steel	HD-PE insulated
	4	2500 mm (98 inch)	steel	HD-PE insulated
	5	4000 mm (157 inch)	steel	HD-PE insulated
	6	6000 mm (236 inch)	steel	HD-PE insulated
	9	Special version		
40	Switch output			
	2	3-wire	PNP	10.8...45 V DC
	4	Relay 20...253 V AC / 20...55 V DC		
	9	Special version		
50	Housing, Cable entry			
	D	F14 Polyester	IP66	Gland M20
	B	F14 Polyester	IP66	Thread NPT ½
	C	F14 Polyester	IP66	Thread G ½
	Y	Special version		
60	Additional option			
	1	Basic version		
	2	Transparent cover		
	9	Special version		
995	Marking			
	1	Tagging (TAG)		
FTC260				Product designation

Accessories

- Adapter**
- FTC260, 1 BSPT female (R_c1), ISO 7/1 (see dimensional sketch):
Part No.: 943215-1001, for 1½ BSPT (R 1½ ISO 7/1), PPS
Part No.: 943215-1021, for 1½ BSP (G 1½ DIN ISO228), PPS
 - FTC260, 1 NPT female:
Part No.: 943215-0042, for 1¼ NPT, steel
Part No.: 943215-0043, for 1¼ NPT, AISI 316Ti (1.4571)
-
- Transparent cover**
- FTC260/262:
Part No.: 943201-1001
-
- Rope shortening set**
- FTC262:
Part No.: 52005918

Supplementary documentation

- Operating manual (BA)**
- Minicap FTC260
KA093F/00/A6
017476-0000
 - Minicap FTC262
KA155F/00/A6
52005985
 - Rope shortening set for FTC262
KA157F/00/A6
-
- Safety instructions (XA)**
- Safety instructions (ATEX) for FTC260
XA011F/00/a3
CE II 1/3 D
52000928
 - Safety instructions (ATEX) for FTC262
XA092F/00/A3
CE II 1/3 D
52005988

Instruments International

Endress+Hauser
Instruments International AG
Kaegenstrasse 2
4153 Reinach
Switzerland

Tel. +41 61 715 81 00
Fax +41 61 715 25 00
www.endress.com
info@ii.endress.com

Endress+Hauser 

People for Process Automation

TI287F/00/EN/05.10
71115351
CCS/FM + SGML6.0



71115351